

# COFFEE TABLE LITH

*designed by Mauro Lipparini 2016*



**BASE:** metal finishes: black nickel or varnished micaceous brown or oxy grey.

**TOP:** mat Emperador marble or sandstone (codes: 5703801, 5703802 and 5703803) or tempered smoked glass (codes: 5703804, 5703805 and 5703806) or "Moon grey" marble (codes: 5703807, 5703809) or "Arabesque grey" marble (code 5703808).

**ATTENTION:** marble is characterized by porosity and cracking that, during the manufacturing process are filled with special resins or inserts in the same material. After the polishing the surface may present irregularities and natural micro holes, which, however, do not compromise the solidity of the product.

For the correct maintenance of all marble surfaces, it is recommended to use neutral detergents and no degreasers nor corrosive detergents. Acid substances may spoil the polished marble surface. It is also recommended to avoid contact with liquids and acid food and to remove immediately these substances if they accidentally come in contact with the surface.

Small table

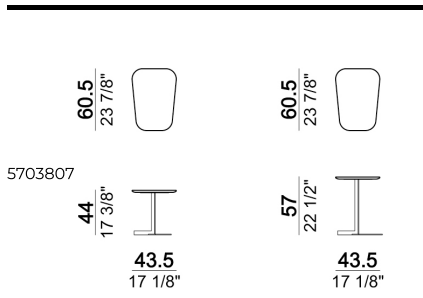

Console

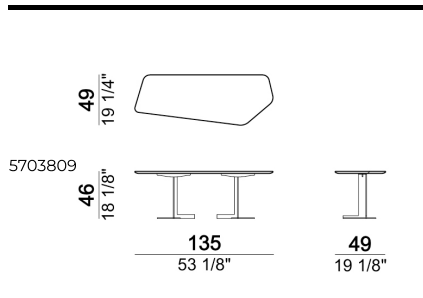

Small table

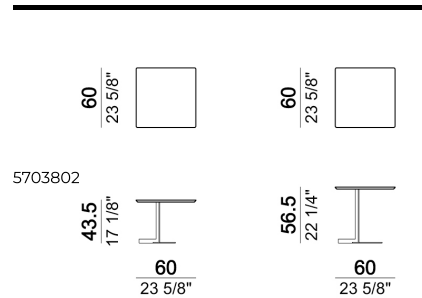

Small table

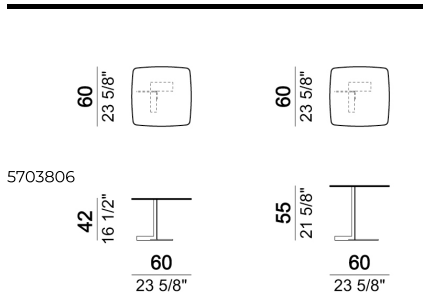

Small table

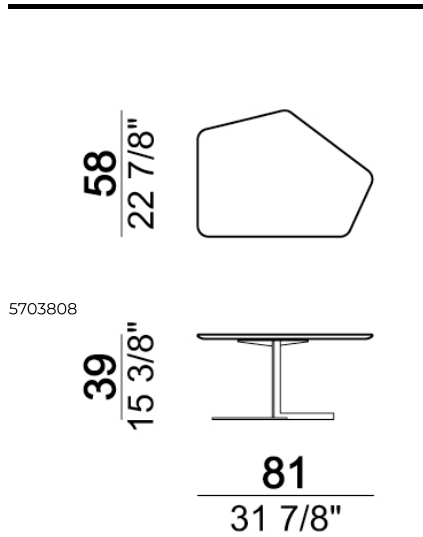

Small table

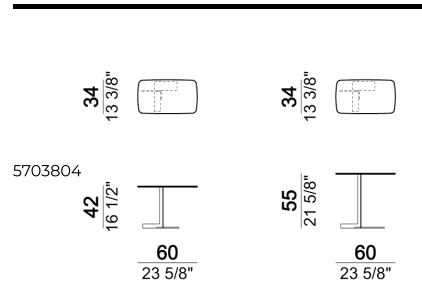

Small table

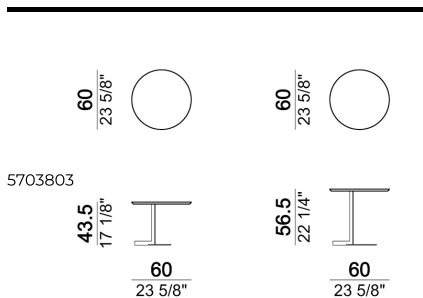

Small table

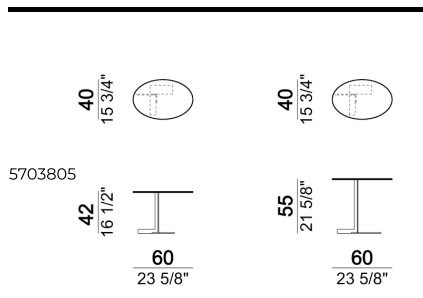

Small table

