

ARKETIPO / INDOOR

# SOFA BROWN SUGAR

*designed by Mauro Lipparini 2018*



**STRUCTURE:** wood.

**STRUCTURE UPHOLSTERY:** expanded polyurethane of varied densities (D40 + D30 + D25) covered with synthetic lining 230gr and coupled synthetic lining 6mm.

**SEAT CUSHION UPHOLSTERY:** expanded polyurethane of varied densities (D35 + memory foam) covered with synthetic lining "Cothem" 300gr.

**BACK CUSHION UPHOLSTERY:** outer cover in 100% twilled downproof cotton lining; filling in mixed feathers (50% goose feathers and 50% polyester fibre).

**SPRINGING:** elastic belts.

**SEAT HEIGHT:** 42 cm - 45 cm with feet h. 15 cm.

**ARM HEIGHT:** 57 cm (LARGE); 67 cm (SLIM).

**FEET:** metal, finishes: black nickel or titanium, or micaceous brown or oxy grey varnished, h.12 cm. On request feet can be supplied 3 cm higher with an extra charge.

**ATTENTION:** Back cushions are not included in the prices but they are required. The dimensions indicated are just a suggestion, they can be changed according to the client's taste.

Sofa / corner sofa SLIM

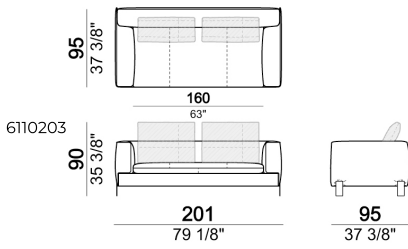

Back cushion

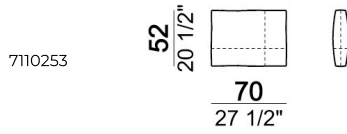

Sofa LARGE

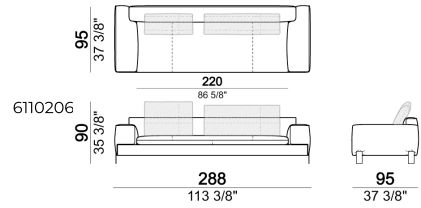

Right or left unit / corner unit

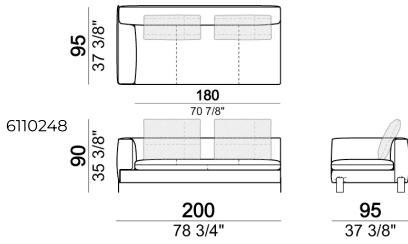

Composition "H" (left unit LARGE 184 cm + right corner unit 174 cm + central unit 180 cm with right pouf + 2 back cushions 110 cm + 1 back cushion 90 cm)

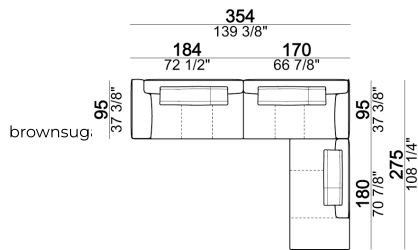

Back cushion

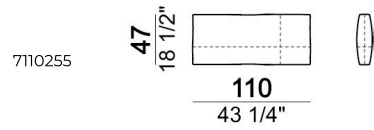

Central unit

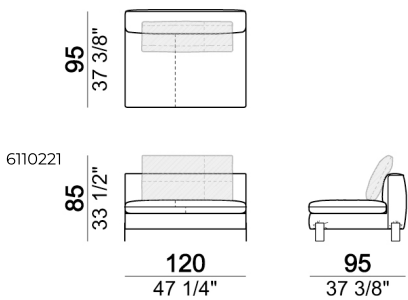

Sofa / corner sofa

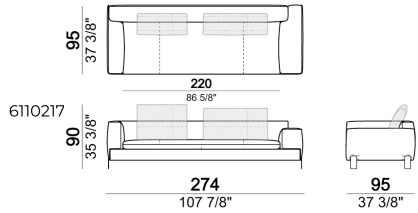

Composition "D" (left unit LARGE 184 cm + chaise longue LARGE with right long arm 131x160 cm + 1 back cushion 110 cm + 1 back cushion 70 cm)

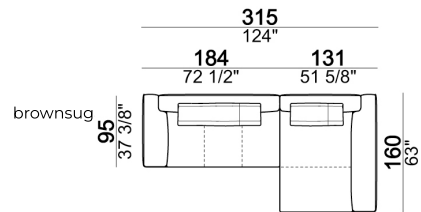

Pouf

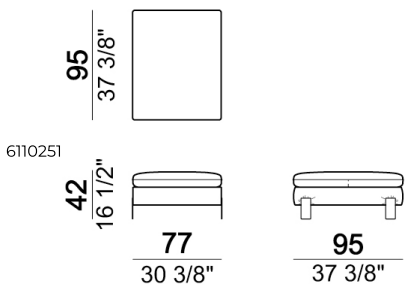

Back cushion

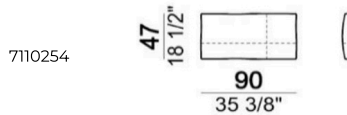

Sofa / corner sofa

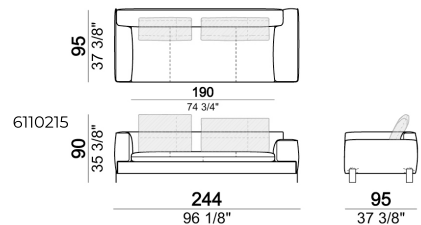

Composition "E" (left unit 204 + chaise longue LARGE with right long arm 131x175 cm + 3 back cushions 70 cm)

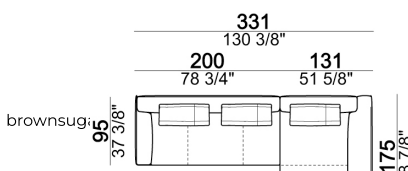

Sofa / corner sofa SLIM

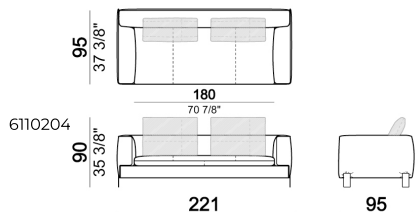

Sofa LARGE

